

# OUTLINE DIMENSIONAL DRAWING

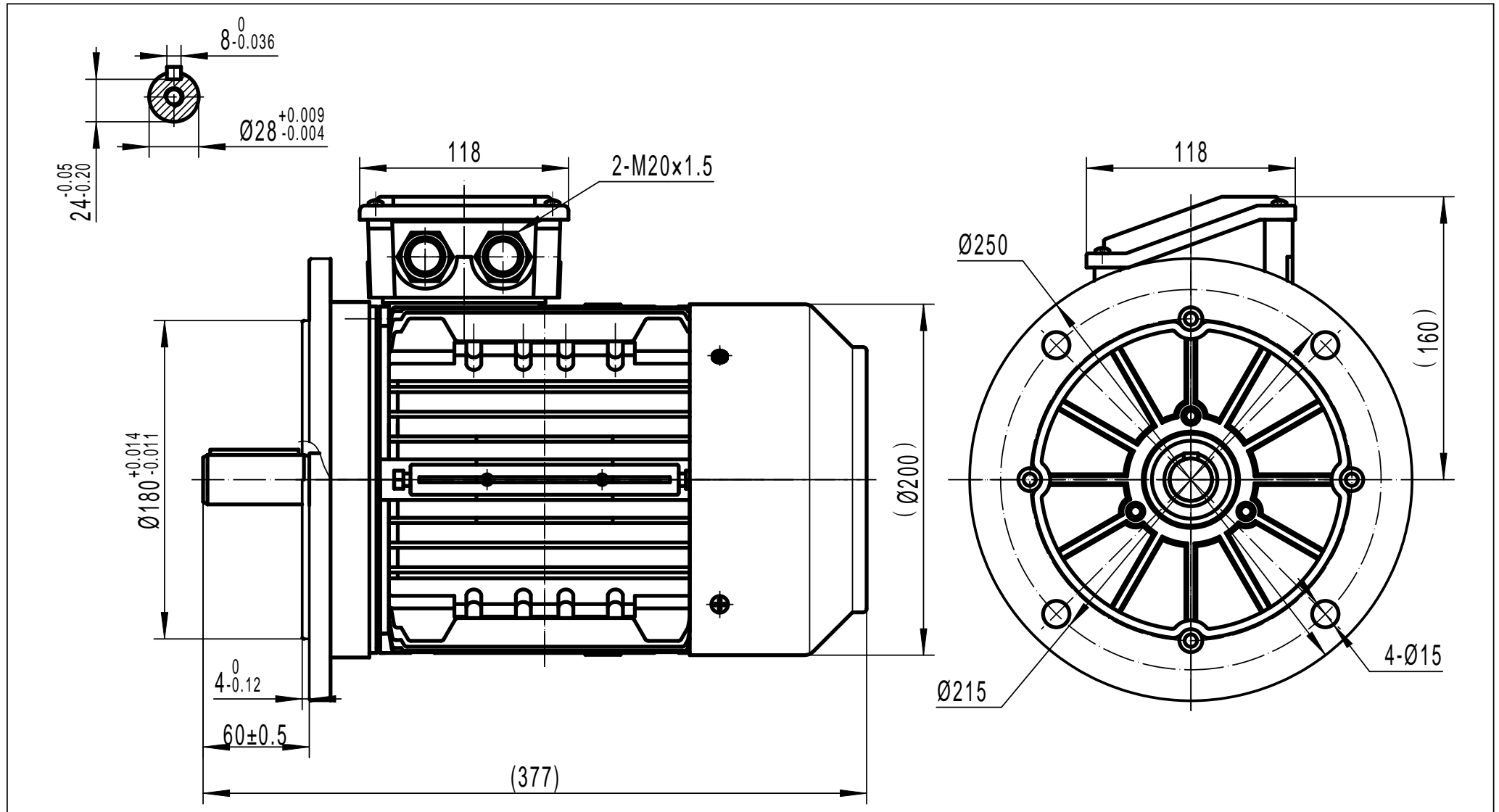

**TECHTOP**  
A U S T R A L I A

TECHTOP AUSTRALIA PTY LTD	
FRAME	TAI 100A B5
DATE	DRAWING NO.
2011/10/14	1ST085.055.001-021 A